

## FEATURES

- A UNIQUE (Patent Pending) TECHNIQUE FOR VERY LOW QUIESCENT CURRENT
- OVER 350 V/ $\mu$ S SLEW RATE
- WIDE SUPPLY VOLTAGE
  - Single Supply: 20V to 350V
  - Split Supplies: +/- 10V to +/- 175V
- OUTPUT CURRENT – Per Amplifier – 150mA cont. ; 200mA Pk
- UP TO 26 WATT DISSIPATION CAPABILITY (DUAL)
- OVER 200 kHz POWER BANDWIDTH

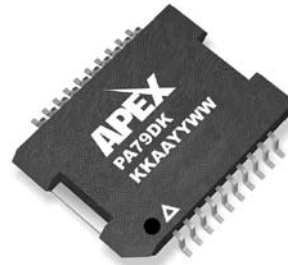

20-PIN PSOP PACKAGE STYLE DK

## APPLICATIONS

- PIEZOELECTRIC POSITIONING AND ACTUATION
- ELECTROSTATIC DEFLECTION
- DEFORMABLE MIRROR ACTUATORS
- CHEMICAL AND BIOLOGICAL STIMULATORS

## DESCRIPTION

The PA79 is a dual high voltage, high speed Precision IC power op amp with performance and unique features not found previously in any commercially available OpAmp. This approach provides a cost-effective, high density solution to applications where multiple amplifiers are required.

Novel input stage design of this amplifier provides extremely high slew rates in pulse applications while maintaining low quiescent current of under 1mA. This novel input stage also has the effect of adding variables to the power response and slew rate characteristics of the amplifier. To a lesser degree, there are also input related effects on unity gain bandwidth and phase. It is important to note that the slew rate is a strong function of input voltage amplitude. **It should be noted that the package tab needs to be connected to a stable reference such as GND for high slew rates. Please refer to special**

## BLOCK DIAGRAM

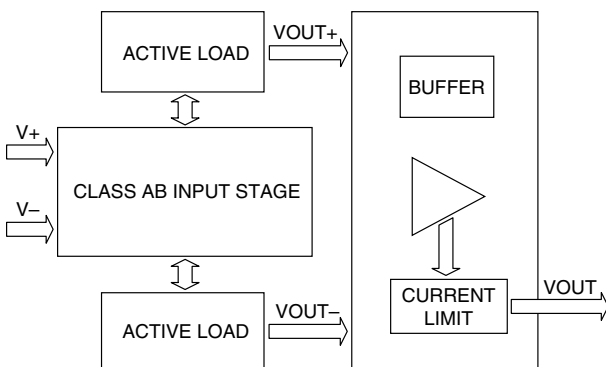

considerations section for details.

The output stages are well protected with user defined current limit although the Safe Operating Area (SOA) must be observed for reliable protection. Proper heatsinking is required for maintaining maximum reliability. External phase compensation provides the user with great flexibility in trading gain, stability and bandwidth.

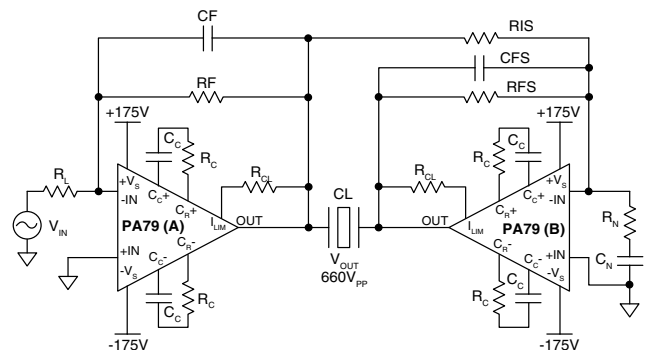

## TYPICAL APPLICATION

The typical application diagram shows a bridge connection of the two amplifiers inside a dual PA79 and provides output voltage swing twice that of one amplifier. Two possible situations where there is an advantage would be in applications with low supply voltages, or applications that operate amplifiers near their maximum voltage ratings in which a single amplifier could not provide sufficient drive. The bridge connection also effectively doubles the slew rate, and non-linearity becomes

### ABSOLUTE MAXIMUM RATINGS

|                                    |                   |
|------------------------------------|-------------------|
| SUPPLY VOLTAGE, $+V_s$ to $-V_s$   | 350V              |
| OUTPUT CURRENT, peak (200ms)       | 200mA, within SOA |
| POWER DISSIPATION, internal, DC    | 14W Single        |
| POWER DISSIPATION, internal, DC    | 26W Dual          |
| INPUT VOLTAGE, Differential        | $\pm 15V$         |
| INPUT VOLTAGE, Common Mode         | $\pm V_s$         |
| TEMPERATURE, junction <sup>2</sup> | 150°C.            |
| TEMPERATURE RANGE, storage         | -55 to 125°C      |
| OPERATING TEMPERATURE, case        | -40 to 125°C      |

### SPECIFICATIONS

| PARAMETER  | TEST CONDITIONS <sup>1</sup>        | MIN      | TYP             | MAX          | UNITS            |
|--|-------------------------------------|----------|-----------------|--------------|------------------|
| <b>INPUT</b>   |                                     |          |                 |              |                  |
| OFFSET VOLTAGE   |                                     | -40      | 8               | 40           | mV               |
| OFFSET VOLTAGE vs. temperature                         | 0 to 125°C (CaseTemperature)        |          | -63             |              | $\mu V/^\circ C$ |
| OFFSET VOLTAGE vs. supply                              |                                     |          |                 | 32           | $\mu V/V$        |
| BIAS CURRENT, initial                                  |                                     |          | 8.5             | 200          | pA               |
| OFFSET CURRENT, initial                                |                                     |          | 12              | 400          | pA               |
| INPUT RESISTANCE, DC                                   |                                     |          | 10 <sup>8</sup> |              | $\Omega$         |
| COMMON MODE VOLTAGE RANGE, pos.                        |                                     |          | $+V_s - 2$      |              | V                |
| COMMON MODE VOLTAGE RANGE, neg.                        |                                     |          | $-V_s + 5.5$    |              | V                |
| COMMON MODE REJECTION, DC                              |                                     | 90       | 118             |              | dB               |
| NOISE  | 700KHz                              |          | 418             |              | $\mu V$ RMS      |
| NOISE, $V_o$ NOISE                                     |                                     |          | 500             |              | nV/ $\sqrt{Hz}$  |
| <b>GAIN</b>  |                                     |          |                 |              |                  |
| OPEN LOOP @ 1Hz  |                                     | 89       | 120             |              | dB               |
| GAIN BANDWIDTH PRODUCT @ 1MHz                          |                                     |          | 1               |              | MHz              |
| PHASE MARGIN   | Full temperature range              |          | 50              |              | °                |
| <b>OUTPUT</b>  |                                     |          |                 |              |                  |
| VOLTAGE SWING  | $I_o = 10mA$                        |          | $ V_s  - 2$     |              | V                |
| VOLTAGE SWING  | $I_o = 100mA$                       |          | $ V_s  - 8.6$   | $ V_s  - 12$ | V                |
| VOLTAGE SWING  | $I_o = 150mA$                       |          | $ V_s  - 10$    |              | V                |
| CURRENT, continuous, DC                                |                                     | 150      |                 |              | mA               |
| SLEW RATE  | <b>Package Tab Connected to GND</b> | 100      | 350             |              | V/ $\mu S$       |
| SETTLING TIME, to 0.1%                                 | 5V Step (No Compensation)           |          | 1               |              | $\mu S$          |
| POWER BANDWIDTH, 300V <sub>P-P</sub>                   | $+V_s = 160V, -V_s = -160V$         |          | 200             |              | kHz              |
| OUTPUT RESISTANCE, No Load                             | $R_{CL} = 6.2\Omega$                |          | 44              |              | $\Omega$         |
| <b>POWER SUPPLY</b>                                    |                                     |          |                 |              |                  |
| VOLTAGE  |                                     | $\pm 10$ | $\pm 150$       | $\pm 175$    | V                |
| CURRENT, quiescent <sup>5</sup>                        | $\pm 150V$ Supply                   | 0.2      | 0.7             | 2.5          | mA               |
| <b>THERMAL</b>   |                                     |          |                 |              |                  |
| RESISTANCE, DC,<br>junction to case, dual <sup>8</sup> | Full temperature range              |          | 4.4             | 4.8          | $^\circ C/W$     |
| RESISTANCE, DC,<br>junction to case, single            | Full temperature range              |          | 8.3             | 9.1          | $^\circ C/W$     |
| RESISTANCE,<br>junction to air                         | Full temperature range              |          | 25              |              | $^\circ C/W$     |
| RESISTANCE,<br>junction to air                         | Full temperature range              |          | 19.1            |              | $^\circ C/W$     |
| TEMPERATURE RANGE, case                                |                                     | -40      |                 | 125          | $^\circ C$       |

- NOTES: 1. Unless otherwise noted: TC = 25°C, DC input specifications are  $\pm$  value given, power supply voltage is typical rating.  
 2. Long term operation at the maximum junction temperature will result in reduced product life. Derate power dissipation to achieve high MTTF.  
 3.  $+V_s$  and  $-V_s$  denote the positive and negative supply voltages of the output stage.  
 4. Rating applies if output current alternates between both output transistors at a rate faster than 60Hz.  
 5. Supply current increases with signal frequency. See graph on page 4. Applies to each amplifier.  
 6. Rating applies when the heatslug of the DK package is soldered to a minimum of 1 square inch foil area of a printed circuit board.  
 7. Rating applies with the JEDEC conditions outlined in the Heatsinking section of this datasheet.  
 8. Rating applies when power dissipation is equal in two amplifiers.

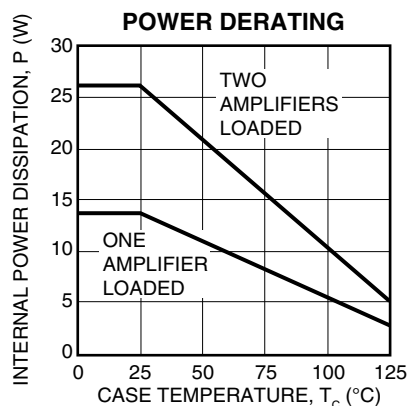
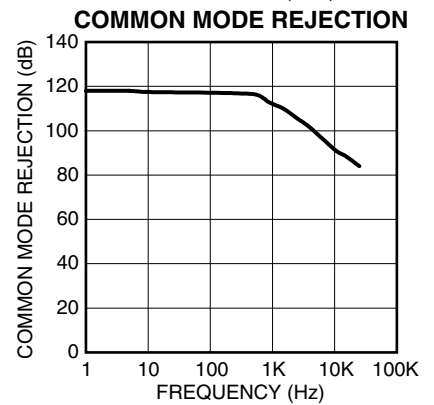
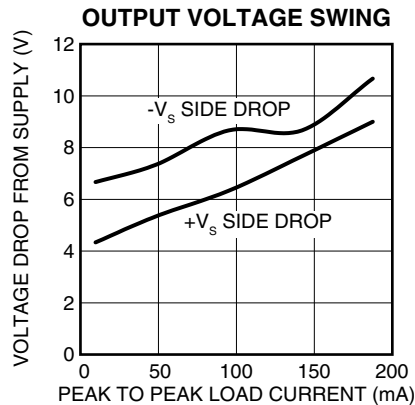
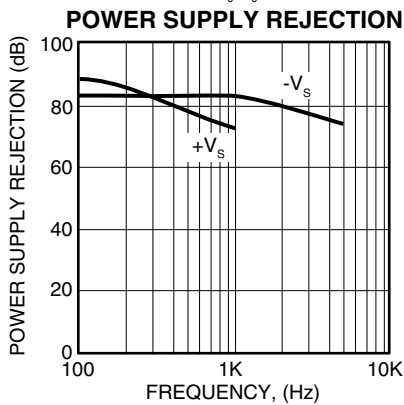
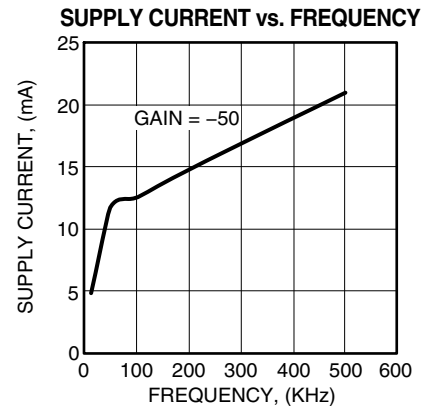
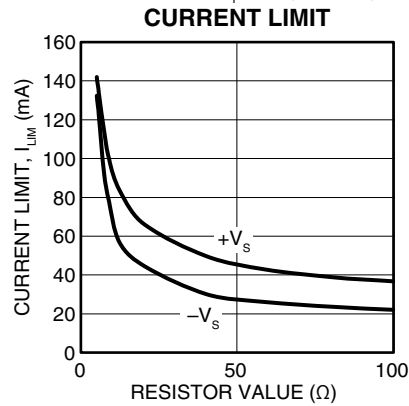
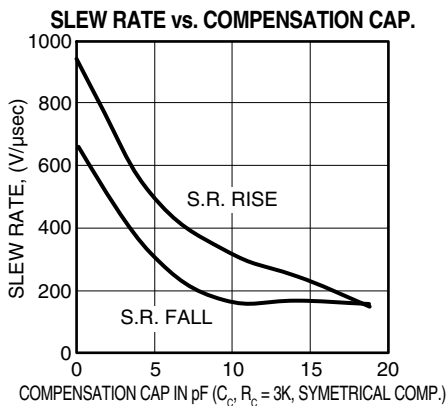
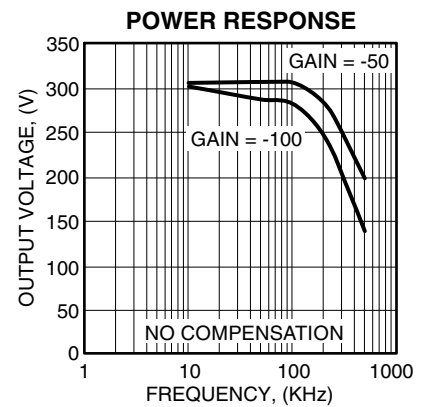
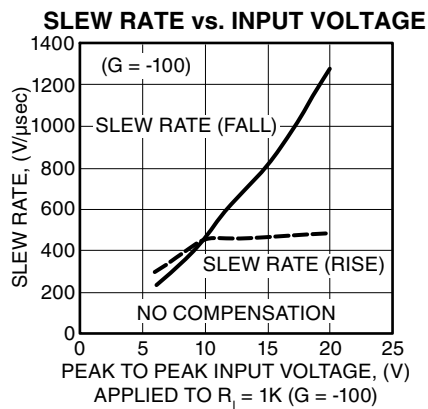
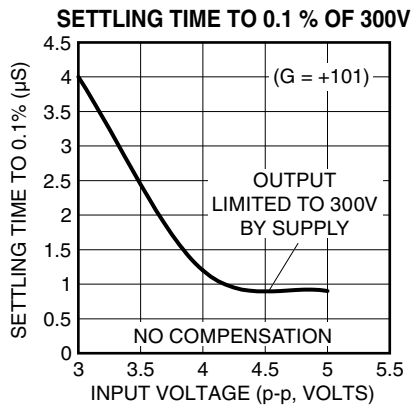

### EXTERNAL CONNECTIONS

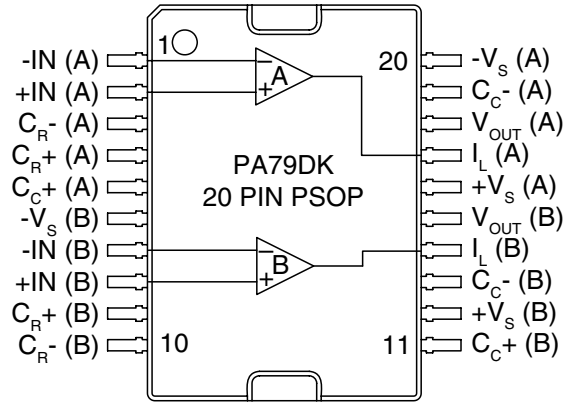

#### NOTES:

1. The package heat slug needs to be connected to a stable reference such as gnd for high slew rates. Please refer to special considerations section for details.
2. Supply bypassing required for  $-V_s$  and  $+V_s$ .
3. For  $C_c$  and  $R_c$  values refer to power supply biasing section.
4. Dimple and ESD triangle denotes pin 1.

### SMALL SIGNAL GAIN AND PHASE PLOTS

The input signal amplitude to the PA79 amplifier is related to the overall phase margin and unity gain bandwidth. For very small signal amplitudes the amplifier phase margin is negative and it shows instability. If small signal stability is desired a constant current source of 500  $\mu$ A (or resistor for constant supply voltage) needs to be added externally between  $C_{c-}$  and  $+V_s$ . This current source has minor effects on output offset voltage but helps immensely with small signal stability. The following gain and phase plots have been generated with a 100k resistor (fixed dual supply voltage  $\pm 50$ V) between  $C_{c-}$  and  $+V_s$ . Please note that the unity gain bandwidth and phase margin improves with larger signal amplitude because of the unique differential amplifier stage in the PA79.

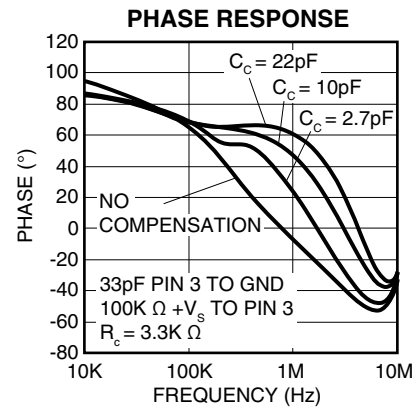
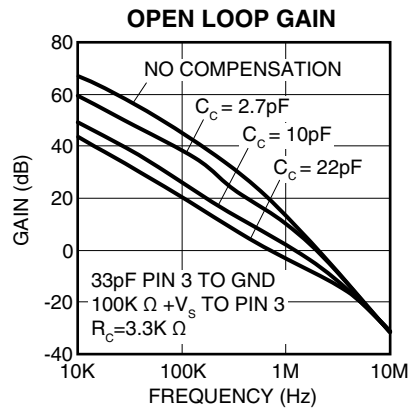

### SAFE OPERATING AREA

The MOSFET output stage of the PA79 is not limited by second breakdown considerations as in bipolar output stages. Only thermal considerations and current handling capabilities limit the SOA. The output stage is protected against transient flyback by the parasitic body diodes of the output stage MOSFET structure. However, for protection against sustained high energy flyback external fast-recovery diodes must be used.

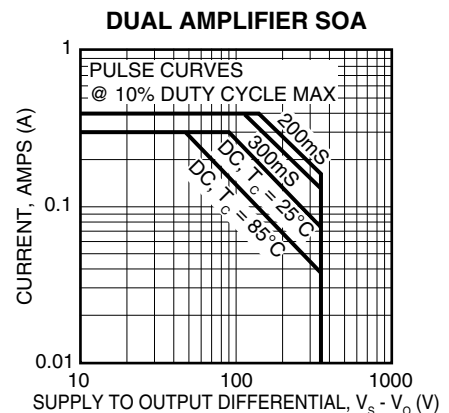
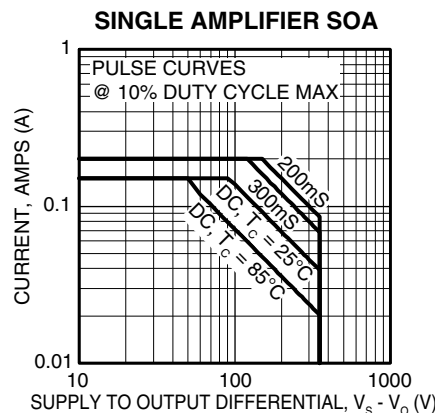

## GENERAL

Please read Application Note 1 “General Operating Considerations” which covers stability, power supplies, heat sinking, mounting, current limit, SOA interpretation, and specification interpretation. Visit [www.apexmicrotech.com](http://www.apexmicrotech.com) for design tools that help automate tasks such as calculations for stability, internal power dissipation, current limit, heat sink selection, Apex’s complete Application Notes library, Technical Seminar Workbook and Evaluation Kits.

## SPECIAL CONSIDERATIONS

**It is very important to realize that in order to achieve high frequency performance the heat sink tab has to be tied to a stable, low impedance reference, i.e. power supply or GND. An AC connection through a 0.1µF capacitor is also sufficient. Internal to the PA79, the heatsink tab is electrically isolated to more than 350V. This may help allay some electrical isolation concerns in tying the heat sink to Vs or GND.**

## CURRENT LIMIT

For proper operation, the current limit resistor,  $R_{LIM}$ , must be connected as shown in the external connections diagram. For maximum reliability and protection, the resistor should be set as high as possible. The maximum practical value using the following formula is 12 ohms. For even lower current limit values, please see the CURRENT LIMIT vs. RESISTOR graph on the TYPICAL PERFORMANCE GRAPHS page.

$$R_{LIM} = 0.7 / I_{LIM}$$

## POWER SUPPLY BYPASSING

Bypass capacitors to power supply terminals +Vs and –Vs must be connected physically close to the pins to prevent local parasitic oscillation in the output stage of the PA79. Use high quality ceramic capacitors (X7R) 0.1µF or greater.

## SUPPLY CURRENT

The PA79 features a class A/B driver stage to drive the output MOSFETs and an innovative input stage to achieve very high slew rates. The supply current drawn by the PA79, even with no load, varies with the slew rate of the output signal.

## MOISTURE SENSITIVITY

The PA79DK has been qualified according to JEDEC 22-A-113-D, MSL 3. The following conditions were used: IR reflow for Pb-free assembly profile where: package thickness is greater than 2.5mm, package volume is greater than 350mm<sup>3</sup>, TP = 245°C.

## HEATSINKING

The PA79DK package has a large exposed integrated copper heatslug to which the monolithic amplifier is directly attached. The solder connection of the heat slug to a 1 square inch foil area on the printed circuit board will result in improved thermal performance of 25C/W. In order to improve the thermal performance, multiple metal layers in the printed circuit board are recommended. This may be adequate heatsinking but the large number of variables involved suggest temperature measurements be made on the top of the package. Do not allow the temperature to exceed 85°C.

The junction to ambient thermal resistance of the DK package can achieve a 19.1C/W rating by using the PCB conditions outlined in JEDEC standard: (JE51–5):

PCB Conditions:

PCB Layers = 4L, Copper, FR–4

PCB Dimensions = 101.6 x 114.3mm

PCB Thickness = 1.6mm

Conditions:

Power dissipation = 2 watt

Ambient Temperature = 55°C

## STABILITY

The PA79 is externally compensated and performance can be tailored to the application. Use the graphs of small signal response and power response as a guide. Due to the innovative design of the PA79, two compensation networks are required. The values of these components should be the same to provide symmetric slew rate characteristics. The compensation capacitor  $C_c$  must be rated at 500V working voltage. NPO capacitors are recommended. The compensation networks  $C_c R_c$  must be mounted closely to the amplifier pins 8 & 11 and 3 & 10 to avoid spurious oscillation.

The PA79 may require an external 33 pF capacitor (minimum breakdown of 350V) between  $C_c$ – and –Vs to prevent oscillations in the falling edge of the output. This capacitor is provided with the evaluation kit. Please refer to EK60U datasheet for details.

## ELECTROSTATIC DISCHARGE

Like many high performance MOSFET amplifiers, the PA79 is very sensitive to damage due to electrostatic discharge (ESD). Failure to follow proper ESD handling procedures could have results ranging from reduced operating performance to catastrophic damage. Minimum proper handling includes the use of grounded wrist or shoe straps, grounded work surfaces. Ionizers directed at the work in progress can neutralize the charge build up in the work environment and are strongly recommended.